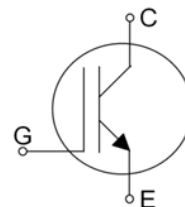
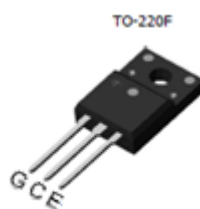

Features:

- 430V Trench Technology
- High Speed Switching
- Low Conduction Loss
- Positive Temperature Coefficient
- Easy parallel Operation
- RoHS compliant
- JEDEC Qualification

Applications :

Plasma Display Panel, Soft switching application,

Ordering Part Number	Package	Packaging type	Marking	Remark
TGPF30N43P	TO-220F	Tube	TGPF30N43P	RoHS
TGPF30N43P-R	TO-220F(R-Forming)	Tube	TGPF30N43P	RoHS
TGPF30N43P-L	TO-220F(L-Forming)	Tube	TGPF30N43P	RoHS

Absolute Maximum Ratings

Parameter	Symbol	Value	Unit	
Collector-Emitter Voltage	V_{CES}	430	V	
Gate-Emitter Voltage	V_{GES}	± 30	V	
Continuous Current	I_c	$T_C = 25\text{ }^\circ\text{C}$	60	A
		$T_C = 100\text{ }^\circ\text{C}$	30	A
Pulsed Collector Current (Note 1)	I_{CM}	300	A	
Power Dissipation	P_D	$T_C = 25\text{ }^\circ\text{C}$	20.8	W
		$T_C = 100\text{ }^\circ\text{C}$	8.3	W
Operating Junction Temperature	T_J	-55 ~ 150	$^\circ\text{C}$	
Storage Temperature Range	T_{STG}	-55 ~ 150	$^\circ\text{C}$	
Maximum lead temperature for soldering purposes, 1/8" from case for 5 seconds	T_L	300	$^\circ\text{C}$	

Notes :

 (1) Repetitive rating : Pulse width limited by max junction temperature, $PW \leq 10\mu\text{s}$, duty cycle $\leq 1\%$.

Thermal Characteristics

Parameter	Symbol	Value	Unit
Maximum Thermal resistance, Junction-to-Case	$R_{\theta JC}$	6.0	$^\circ\text{C/W}$
Maximum Thermal resistance, Junction-to-Ambient	$R_{\theta JA}$	62.5	$^\circ\text{C/W}$

Electrical Characteristics of the IGBT $T_C=25^\circ\text{C}$, unless otherwise noted

Parameter	Symbol	Test condition	Min	Typ	Max	Units
OFF						
Collector – Emitter Breakdown Voltage	BV_{CES}	$V_{GE} = 0V, I_C = 1mA$	430	--	--	V
Zero Gate Voltage Collector Current	I_{CES}	$V_{CE} = 430V, V_{GE} = 0V$	--	--	100	μA
Gate – Emitter Leakage Current	I_{GES}	$V_{CE} = 0V, V_{GE} = \pm 30V$	--	--	± 250	nA

ON						
Gate – Emitter Threshold Voltage	$V_{GE(TH)}$	$V_{GE} = V_{CE}, I_C = 1mA$	2	3.1	4.5	V
Collector – Emitter Saturation Voltage	$V_{CE(SAT)}$	$V_{GE} = 15V, I_C = 30A, T_J = 25^\circ\text{C}$	--	1.4	2.0	V
		$V_{GE} = 15V, I_C = 30A, T_J = 125^\circ\text{C}$	--	1.52	--	V

DYNAMIC						
Input Capacitance	C_{IES}	$V_{CE} = 25V,$ $V_{GE} = 0V,$ $f = 1MHz$	--	845	--	pF
Output Capacitance	C_{OES}		--	50	--	pF
Reverse Transfer Capacitance	C_{RES}		--	23	--	pF

SWITCHING						
Turn-On Delay Time	$t_{d(on)}$	$V_{CC} = 150V, I_C = 30A,$ $R_G = 5\Omega, V_{GE} = 15V,$ Resistive Load, $T_J = 25^\circ\text{C}$	--	13	--	ns
Rise Time	t_r		--	105	--	ns
Turn-Off Delay Time	$t_{d(off)}$		--	35	--	ns
Fall Time	t_f		--	160	--	ns
Turn-On Delay Time	$t_{d(on)}$	$V_{CC} = 150V, I_C = 30A,$ $R_G = 5\Omega, V_{GE} = 15V,$ Resistive Load, $T_J = 125^\circ\text{C}$	--	14	--	ns
Rise Time	t_r		--	145	--	ns
Turn-Off Delay Time	$t_{d(off)}$		--	40	--	ns
Fall Time	t_f		--	240	--	ns
Total Gate Charge	Q_g	$V_{CC} = 150V, I_C = 30A,$ $V_{GE} = 15V$	--	26	--	nC
Gate-Emitter Charge	Q_{ge}		--	3.1	--	nC
Gate-Collector Charge	Q_{gc}		--	9	--	nC

Fig. 1 Output characteristics

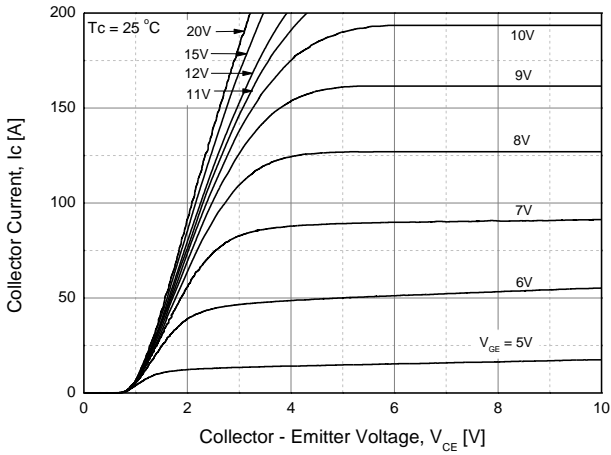

Fig. 2 Saturation voltage characteristics

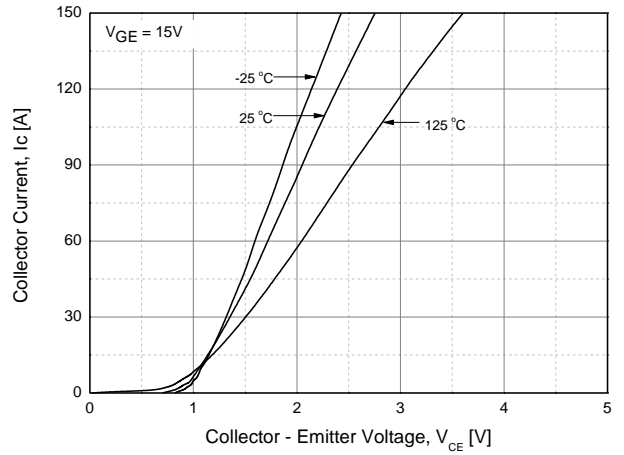

Fig. 3 Saturation voltage vs. collector current

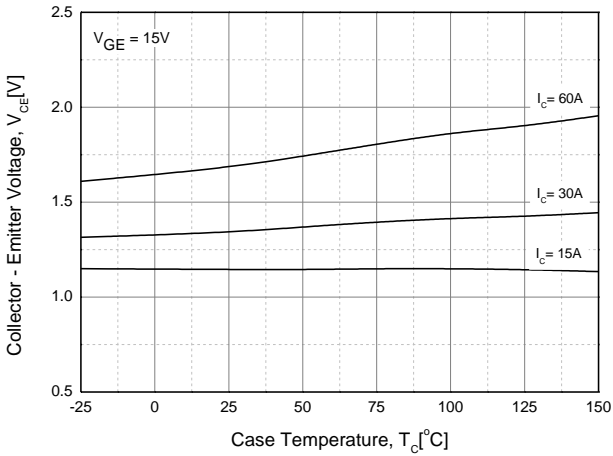

Fig. 4 Saturation voltage vs. gate bias

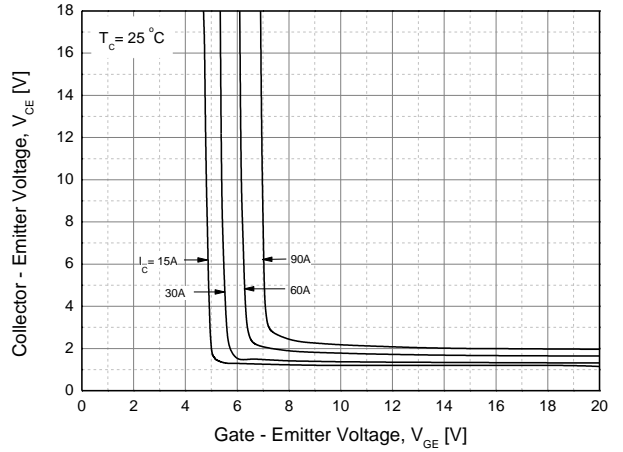

Fig. 5 Saturation voltage vs. gate bias

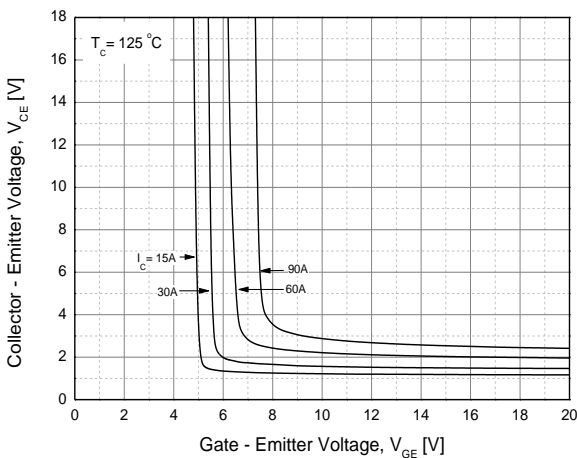

Fig. 6 Capacitance characteristics

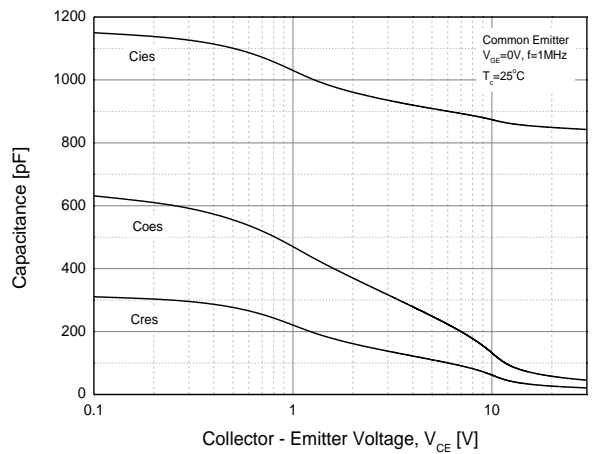

Fig. 7 Turn on time vs. gate resistance

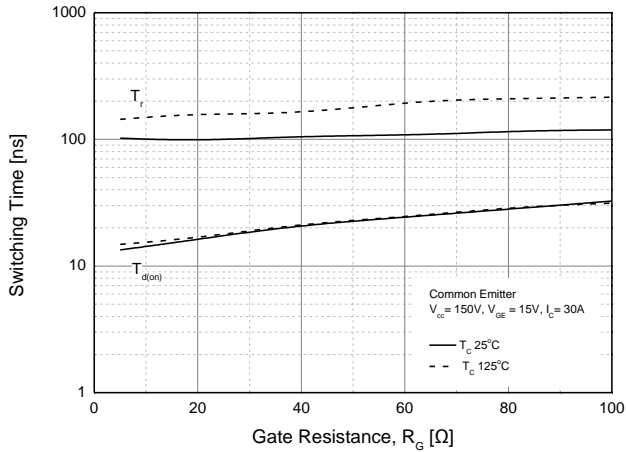

Fig. 8 Turn on time vs. collector current

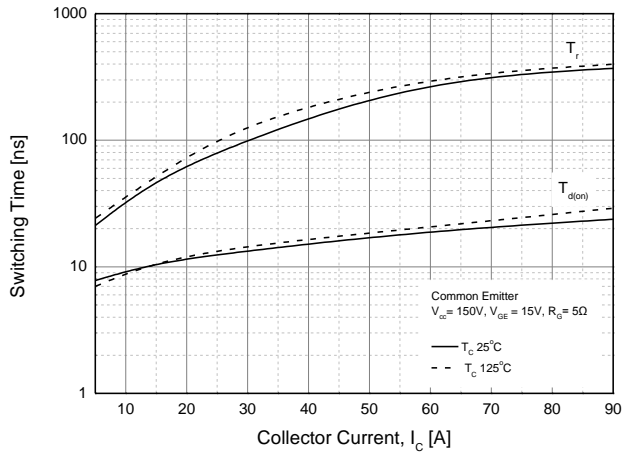

Fig. 9 Turn on time vs. Case temperature

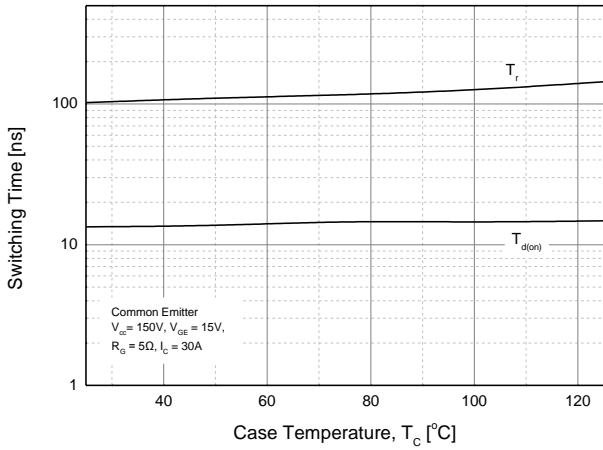

Fig. 10 Turn off time vs. gate resistance

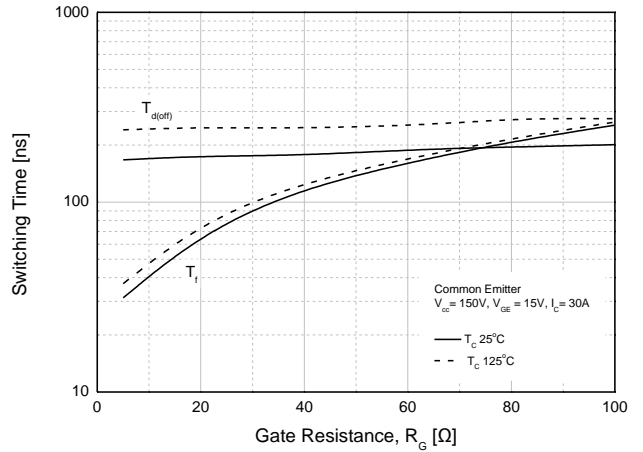

Fig. 11 Turn off time vs. collector current

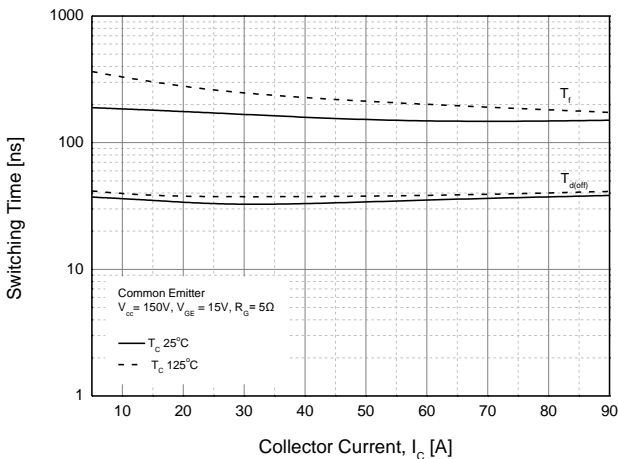

Fig. 12 Turn off time vs. Case temperature

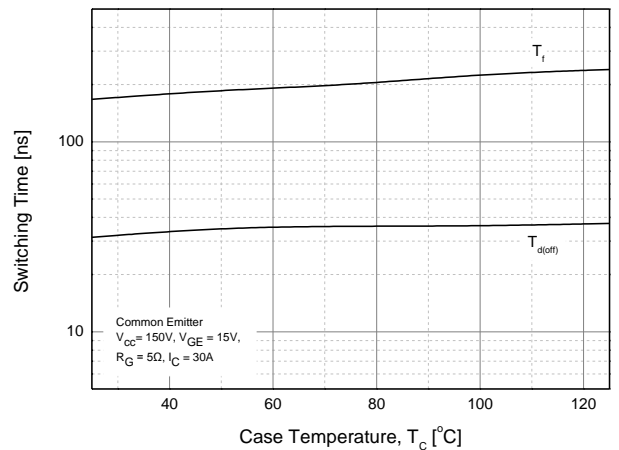

Fig. 13 Gate charge characteristics

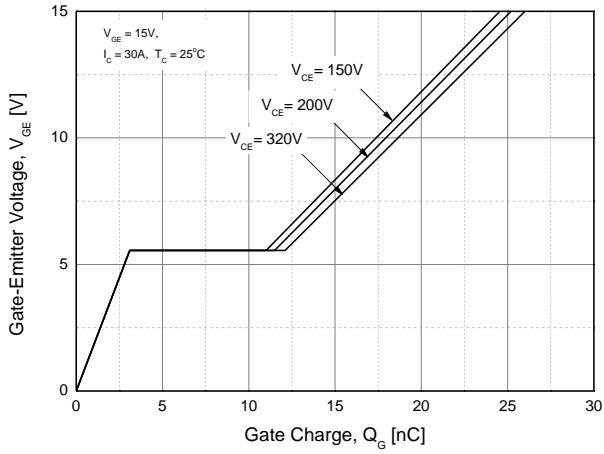

Fig. 14 SOA

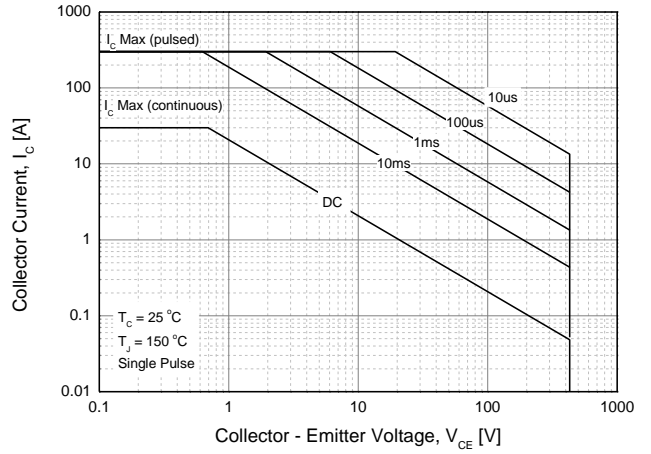

Fig. 15 RBSOA

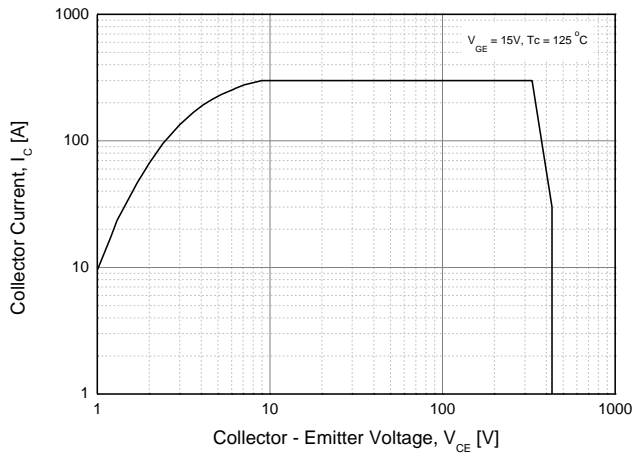
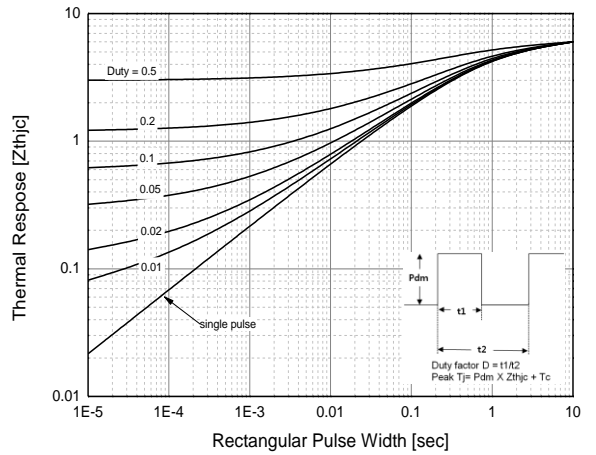
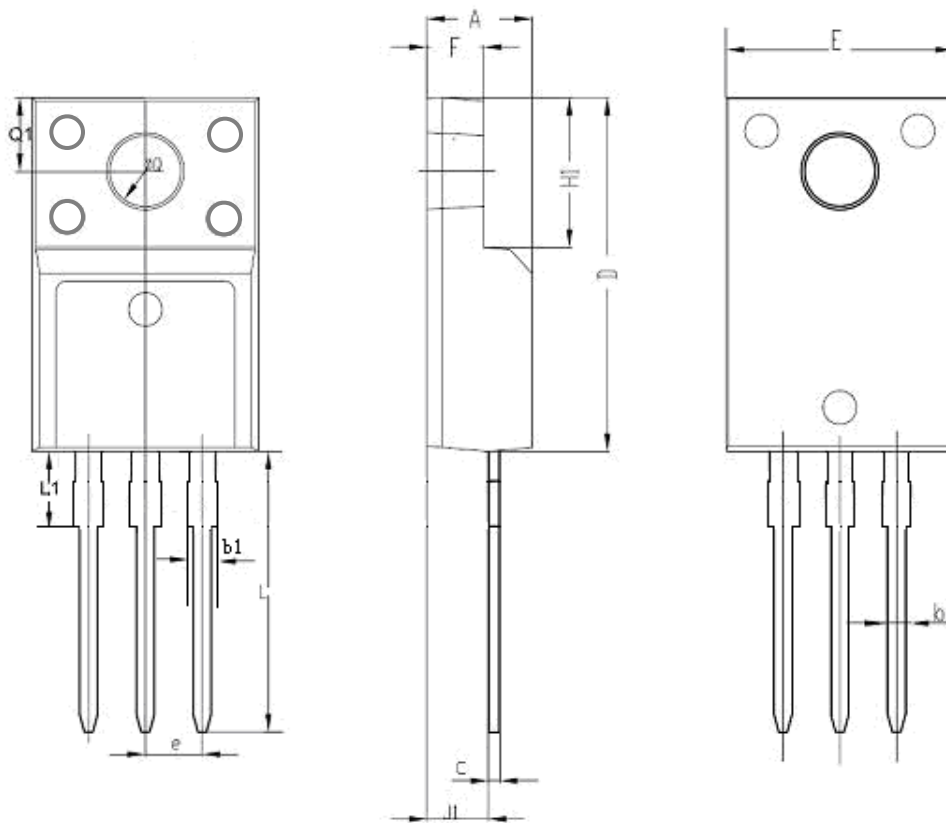

Fig. 16 Transient thermal impedance



TO-220F-3L MECHANICAL DATA



SYMBOL	INCHES		MILLIMETERS		NOTES
	MIN	MAX	MIN	MAX	
A	0.178	0.194	4.53	4.93	
b	0.028	0.036	0.71	0.91	
C	0.018	0.024	0.45	0.60	
D	0.617	0.633	15.67	16.07	
E	0.392	0.408	9.96	10.36	
e	0.100 TYP.		2.54TYP.		
H1	0.256	0.272	6.50	6.90	
J1	0.101	0.117	2.56	2.96	
L	0.503	0.519	12.78	13.18	
φQ	0.117	0.133	2.98	3.38	
b1	0.045	0.055	1.15	1.39	
L1	0.114	0.130	2.9	3.3	
Q1	0.122	0.138	3.10	3.50	
F	0.092	0.108	2.34	2.74	